

Detail set for 4006

Instruction sheet for resin and photo-etched parts

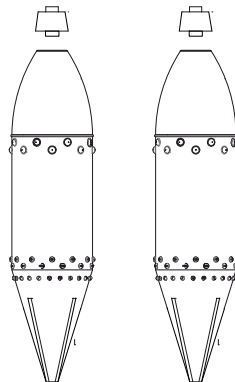
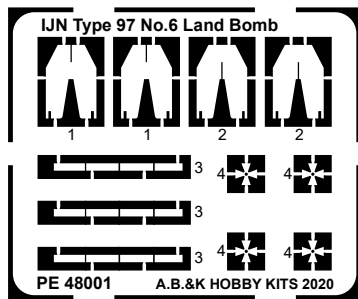
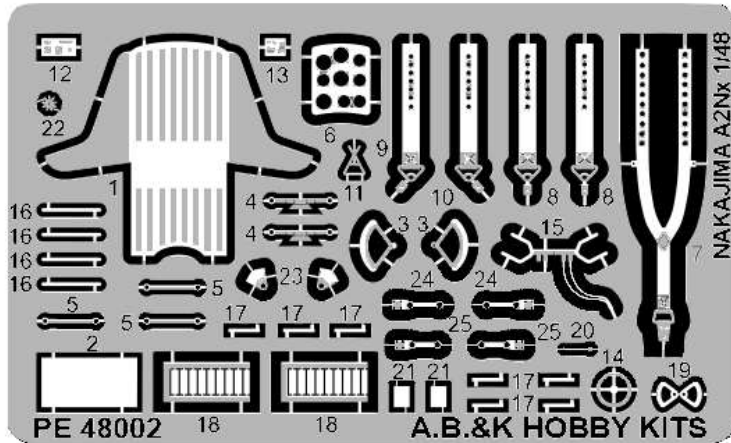

1 Modification of part A2 from kit

2

3

4

5

6

wire \varnothing 0,4mm

Modification of part A5 from kit

3,6mm 5,6mm

7

A5

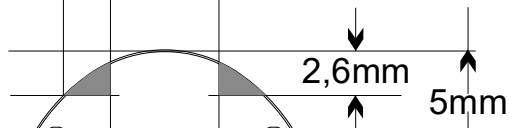

Mod.part A5

Decal 15

6

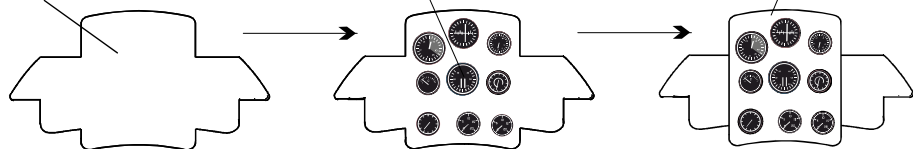

8

14

7

20

19

11

∅ 0,2mm

9 ? 10

8

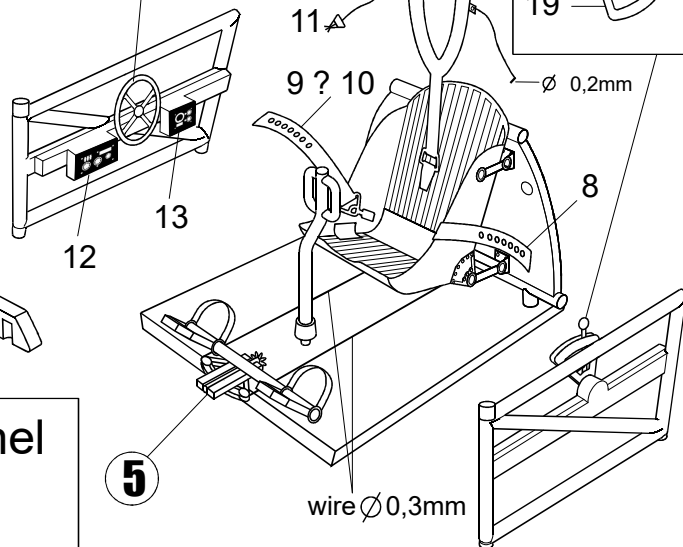

wire ∅ 0,3mm

5

Instrument panel

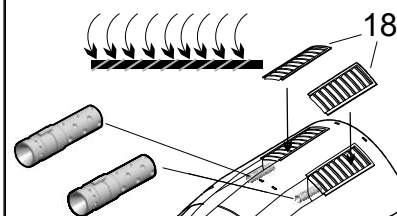
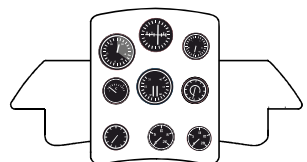

9

10

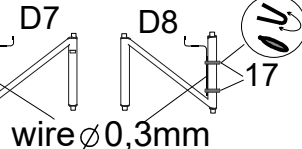

wire ∅ 0,3mm

11



wire ∅ 0,3mm

D4

16

15

19mm

wire ∅ 0,3mm

12

